

AGE3 CIRCULATOR | SINGLE-HEAD VARIABLE SPEED | 65-180 | SUBMITTAL

File No: 10.8574IEC
Date: FEBRUARY 25, 2020
Supersedes: 10.8574IEC
Date: MAY 10, 2017

Job: _____ Representative: _____
 _____ Ordered by: _____ Date: _____
 Engineer: _____ Submitted by: _____ Date: _____
 Contractor: _____ Approved by: _____ Date: _____

PUMP DETAILS

TAG	MODEL	FLOW	HEAD	SYSTEM	LOCATION

MOTOR DESIGN DATA

Motor enclosure: IP44
Power supply: 230/1/50
Insulation class: F
Motor efficiency: $EEI \leq 0.23$
Inverter/motor type: ECM/Permanent magnet
Motor speed: Variable speed

ELECTRICAL DATA

1x230,50HZ, IEC38	P1[W]	I [AMPS]
Auto min.	20	3
Auto max.	1500	6.7

ELECTRICAL CONNECTION

Type: 3 wires (L,N,Earth)
Connector: 3 pins connector & cable gland

BMS CONNECTIVITY

Input/output: 1 x analogue I/O, 1 x digital I/O and 1 x relay
Serial communication: Modbus RTU and Ethernet

MATERIALS OF CONSTRUCTION

Impeller: Stainless steel
Casing gasket: EPDM 70 Shore
Bearings: Graphite
Pump casing: Cast iron
Shaft: Stainless steel
Can: Stainless steel

MECHANICAL CONNECTION

Type: Flanged
Pressure rating: PN10
Size: DN65

ENVIRONMENT LIMIT DATA

Water temp max: 110 °C
Water temp min : 2 °C
Ambient temp. max: 40 °C
Min. pressure: 0.05 BAR < 50 °C,
 0.8 BAR < 80 °C,
 1.4 BAR < 110 °C

DIMENSIONS

A	B	C	D	E	WEIGHT
mm (inches)					kg (lbs)
403 (15.9)	80 (3.1)	340 (13.4)	95 (3.7)	127 (5.0)	39.0 (86.0)

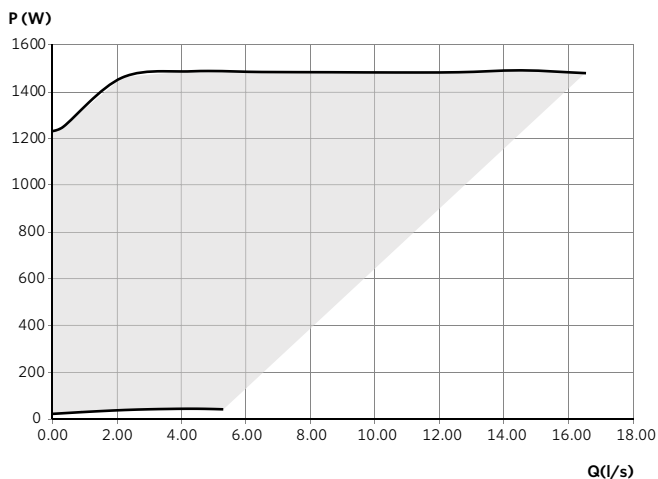
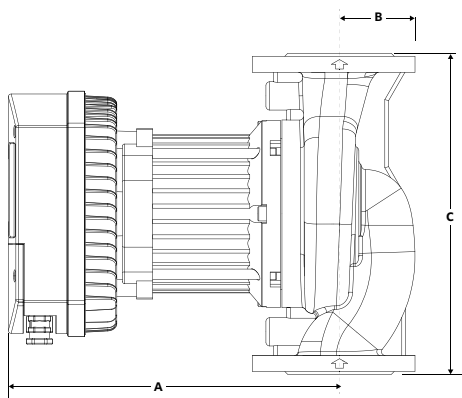
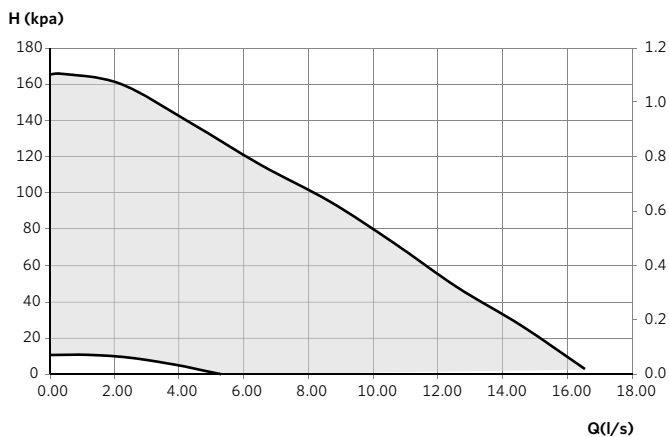
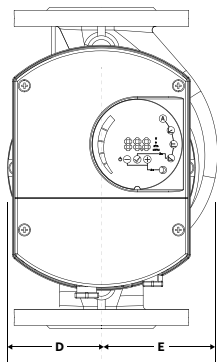

TORONTO

+1 416 755 2291

BUFFALO

+1 716 693 8813

BIRMINGHAM

+44 (0) 8444 145 145

MANCHESTER

+44 (0) 8444 145 145

BANGALORE

+91 (0) 80 4906 3555

SHANGHAI

+86 (0) 21 5237 0909

SÃO PAULO

+55 11 4785 1330

LYON

+33 (0) 420 102 625

DUBAI

+971 4 887 6775

MANNHEIM

+49 (0) 621 3999 9858