

## DESIGN ENVELOPE 4302 DUALARM | 0608-010.0 | SUBMITTAL

File No: 104.5031  
Date: DECEMBER 16, 2020  
Supersedes: 104.5031  
Date: JULY 8, 2019

Job: \_\_\_\_\_ Representative: \_\_\_\_\_

Order No: \_\_\_\_\_ Date: \_\_\_\_\_

Engineer: \_\_\_\_\_ Submitted by: \_\_\_\_\_ Date: \_\_\_\_\_

Contractor: \_\_\_\_\_ Approved by: \_\_\_\_\_ Date: \_\_\_\_\_

### PUMP DESIGN DATA

No. of pumps: \_\_\_\_\_ Tag: \_\_\_\_\_  
Total system design flow: \_\_\_\_\_ USgpm(L/s)  
Head: \_\_\_\_\_ ft(m) Capacity split \_\_\_\_\_ %  
Flow per pump head: \_\_\_\_\_ USgpm(L/s)  
Parallel flow: \_\_\_\_\_ USgpm(L/s)  
Liquid: \_\_\_\_\_ Viscosity: \_\_\_\_\_  
Temperature: \_\_\_\_\_ °F (°C) Specific gravity: \_\_\_\_\_  
Suction: 6" (150mm) Discharge: 6" (150mm)

**OSHPD Seismic Certification OSP-0422-10  
UL STD 778 & CSA STD C22.2 NO.108 certified  
Test report is supplied with each pump**

### MOTOR DESIGN DATA

HP: \_\_\_\_\_ RPM: \_\_\_\_\_ Frame size: \_\_\_\_\_  
Enclosure: \_\_\_\_\_ Volts: \_\_\_\_\_ Hertz: 60 Hz  
Phase: 3 Efficiency: NEMA premium 12.12

### MAXIMUM PUMP OPERATING CONDITIONS

#### ANSI 125 - (CONSTRUCTION: BF)

175 psig at 150°F (12 bar at 65°C)  
140 psig at 250°F (10 bar at 121°C)

### MECHANICAL SEAL DESIGN DATA

See file no. 43.50 for standard mechanical seal details as indicated below

Armstrong seal reference number

c1 (a)  Others: \_\_\_\_\_

### CONTROLS DATA

**Protocol (standard):**  BACnet™ MS/TP

BACnet™ TCP/IP

Modbus RTU

**Enclosure:**  Indoor - UL TYPE 12

Outdoor - UL TYPE 4X with Weather Shield

Outdoor - UL TYPE 4X less Weather Shield

**Fused disconnect switch:**

**EMI/RFI control:** Integrated filter designed to meet EN61800-3

**Harmonic suppression:** Dual DC-link reactors (Equivalent: 5% AC line reactor) Supporting IEEE 519-1992 requirements\*\*

**Cooling:** Fan-cooled through back channel

**Ambient temperature:** -10°C to +45°C up to 1000 meters above sea level (+14°F to +113°F, 3300 ft)

**Analog I/O:** Two current or voltage inputs, one speed output

**Digital I/O:** Two inputs, two outputs

**Pulse inputs:** Two programmable

**Relay outputs:** Two programmable

**Communication port:** 1-RS485

\*\* The IVS drive is a low harmonic drive via built-in DC line reactors. This does not guaranty performance to any system wide harmonic specification or the costs to meet a system wide specification. If supplied with the system electrical details, Armstrong will run a computer simulation of the system wide harmonics. If system harmonic levels are exceeded Armstrong can also recommend additional harmonic mitigation and the costs for such mitigation.

### FLOW READOUT ACCURACY

The Design Envelope model selected will provide flow reading on the controls local keypad & digitally for the BMS. The model readout will be factory tested to ensure ±5% accuracy.

## OPTIONS

### SENSORLESS BUNDLE (STANDARD)



Operation of pump without a remote sensor. Includes:

- Sensorless control
- Flow readout
- Constant flow
- Constant pressure

Minimum system pressure to be maintained \_\_\_\_\_ ft (m)

\* If minimum maintained system pressure is not known: Default to 40% of design head

### PARALLEL SENSORLESS



Operation of multiple pumps without a remote sensor

Minimum system pressure to be maintained \_\_\_\_\_ ft (m)

\* If minimum maintained system pressure is not known: Default to 40% of design head

### ENERGY PERFORMANCE BUNDLE



Provides energy savings on oversized systems by adjusting pump parameters to on-site conditions. Includes:

- **Auto-flow balancing** - Automatically determines control curve between design flow at on-site system head, and minimum (zero-head) flow for energy savings
- **Maximum flow control** - Limits flow rate to pre-set maximum for potential energy savings

Maximum flow rate \_\_\_\_\_ gpm (L/s)

\*Only available if sensorless bundle is enabled

\*Available in single pump operation only

### PROTECTION BUNDLE



Protects other flow sensitive equipment by setting limits of pump operation. Includes:

- **Minimum flow control** - Attempts to maintain flow rate to pre-set minimum to protect equipment in system
- **Bypass valve control** - Actuates a bypass valve to protect flow sensitive equipment if pre-set minimum flow rate is reached

Minimum flow rate \_\_\_\_\_ gpm (L/s)

\*Only available if sensorless bundle is enabled

### DUAL SEASON SETUP



Pre-sets heating and cooling parameters for pumps in 2-pipe systems

#### Cooling

Duty point \_\_\_\_\_ gpm (L/s) at \_\_\_\_\_ ft (m)

Minimum system pressure to be maintained \_\_\_\_\_ ft (m)

#### Heating

Duty point \_\_\_\_\_ gpm (L/s) at \_\_\_\_\_ ft (m)

Minimum system pressure to be maintained \_\_\_\_\_ ft (m)

\*Available in single pump operation only

## OPTIONAL SERVICES

### ON-SITE PUMP COMMISSIONING



### PUMP MANAGER



Online service for sustained pump performance and enhanced reliability.

Available in 3 or 5 year terms

\* Requires an internet connection to be provided by building

\* Includes an extended warranty for parts and labour

(wearable parts excluded)

3

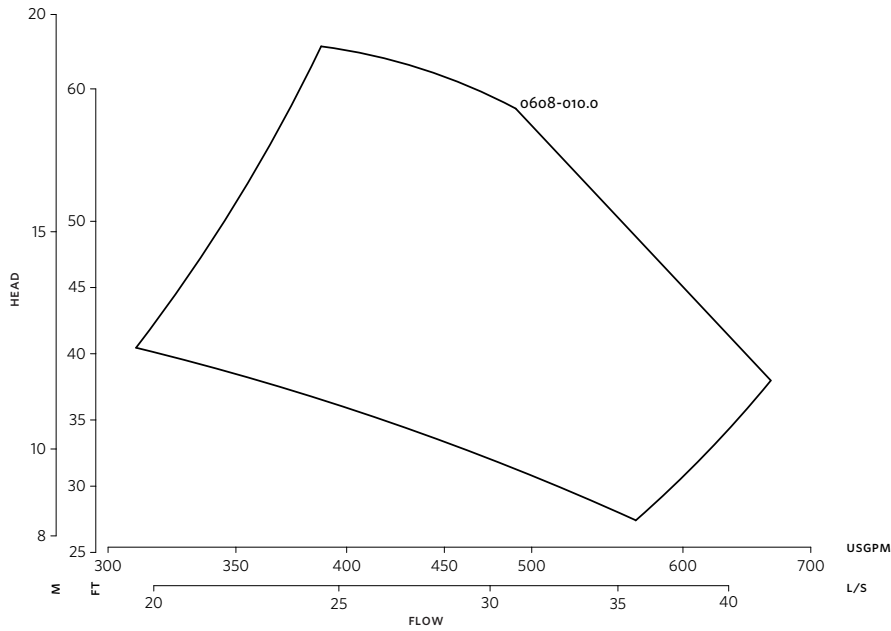

**DIMENSION DATA**

	INDOOR (UL TYPE 12/ODP)	OUTDOOR (UL TYPE 4X/TEFC)
<b>Frame size:</b>	215	215
<b>Size:</b>	6×6×8	6×6×8
<b>HP:</b>	10	10
<b>RPM:</b>	1800	1800
<b>AB:</b>	31.89(810)	37.68(957)
<b>B1:</b>	9.75(248)	9.75(248)
<b>B2:</b>	9.75(248)	9.75(248)
<b>C1:</b>	16.90(429)	16.90(429)
<b>C2:</b>	17.59(447)	17.59(447)
<b>D1:</b>	16.75(425)	16.75(425)
<b>D2:</b>	16.75(425)	16.75(425)
<b>E:</b>	7.59(193)	8.25(210)
<b>P:</b>	12.13(308)	11.25(286)
<b>F:</b>	16.73(425)	20.25(514)
<b>SD:</b>	33.88(860)	33.88(860)
<b>T:</b>	7.875(200)	7.875(200)
<b>XY:</b>	28.19(716)	29.32(745)
<b>Weight:</b>	872(395.5)	956(433.6)

Performance curves are for reference only.  
Confirm current performance data with Armstrong ACE Online selection software.

Dimensions - inch (mm)  
Weight - lbs (kg)

**INDOOR**

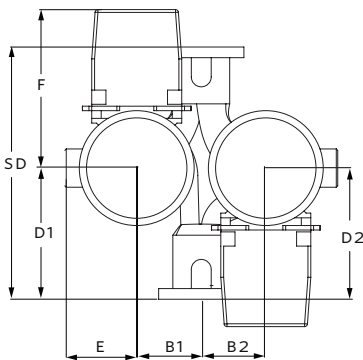

**OUTDOOR**

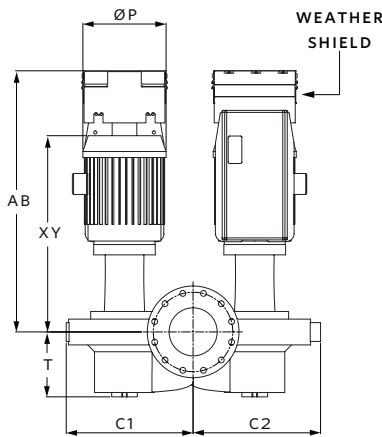
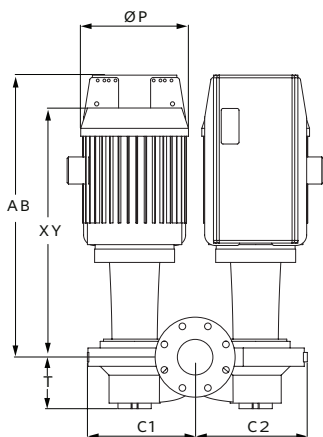
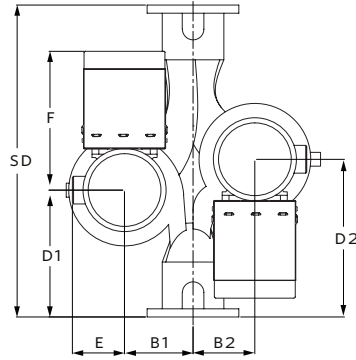

- Tolerance of ±0.125" (±3 mm) should be used
- For exact installation, data please write factory for certified dimensions

**TORONTO**

23 BERTRAND AVENUE  
TORONTO, ONTARIO  
CANADA, M1L 2P3  
+1 416 755 2291

**BUFFALO**

93 EAST AVENUE  
NORTH TONAWANDA, NEW YORK  
U.S.A., 14120-6594  
+1 716 693 8813

**BIRMINGHAM**

HEYWOOD WHARF, MUCKLOW HILL  
HALESOWEN, WEST MIDLANDS  
UNITED KINGDOM, B62 8DJ  
+44 8444 145 145

**MANCHESTER**

WOLVERTON STREET  
MANCHESTER  
UNITED KINGDOM, M11 2ET  
+44 8444 145 145

**BANGALORE**

#59, FIRST FLOOR, 3RD MAIN  
MARGOSA ROAD, MALLESWARAM  
BANGALORE, INDIA, 560 003  
+91 80 4906 3555

**SHANGHAI**

UNIT 903, 888 NORTH SICHUAN RD.  
HONGKOU DISTRICT, SHANGHAI  
CHINA, 200085  
+86 21 5237 0909

**SÃO PAULO**

RUA JOSÉ SEMIÃO RODRIGUES AGOSTINHO,  
1370 GALPÃO 6 EMBU DAS ARTES  
SAO PAULO, BRAZIL  
+55 11 4785 1330

**LYON**

93 RUE DE LA VILLETTE  
LYON, 69003 FRANCE  
+33 4 26 83 78 74

**DUBAI**

JAFZA VIEW 19, OFFICE 402  
P.O.BOX 18226 JAFZA,  
DUBAI - UNITED ARAB EMIRATES  
+971 4 887 6775

**MANNHEIM**

DYNAMOSTRASSE 13  
68165 MANNHEIM  
GERMANY  
+49 621 3999 9858